

NOTE: TYPICAL CONC DADO PANEL DETAIL UP TO 2400 AFFL
PD.01 Plan Detail PD.01
 1:10

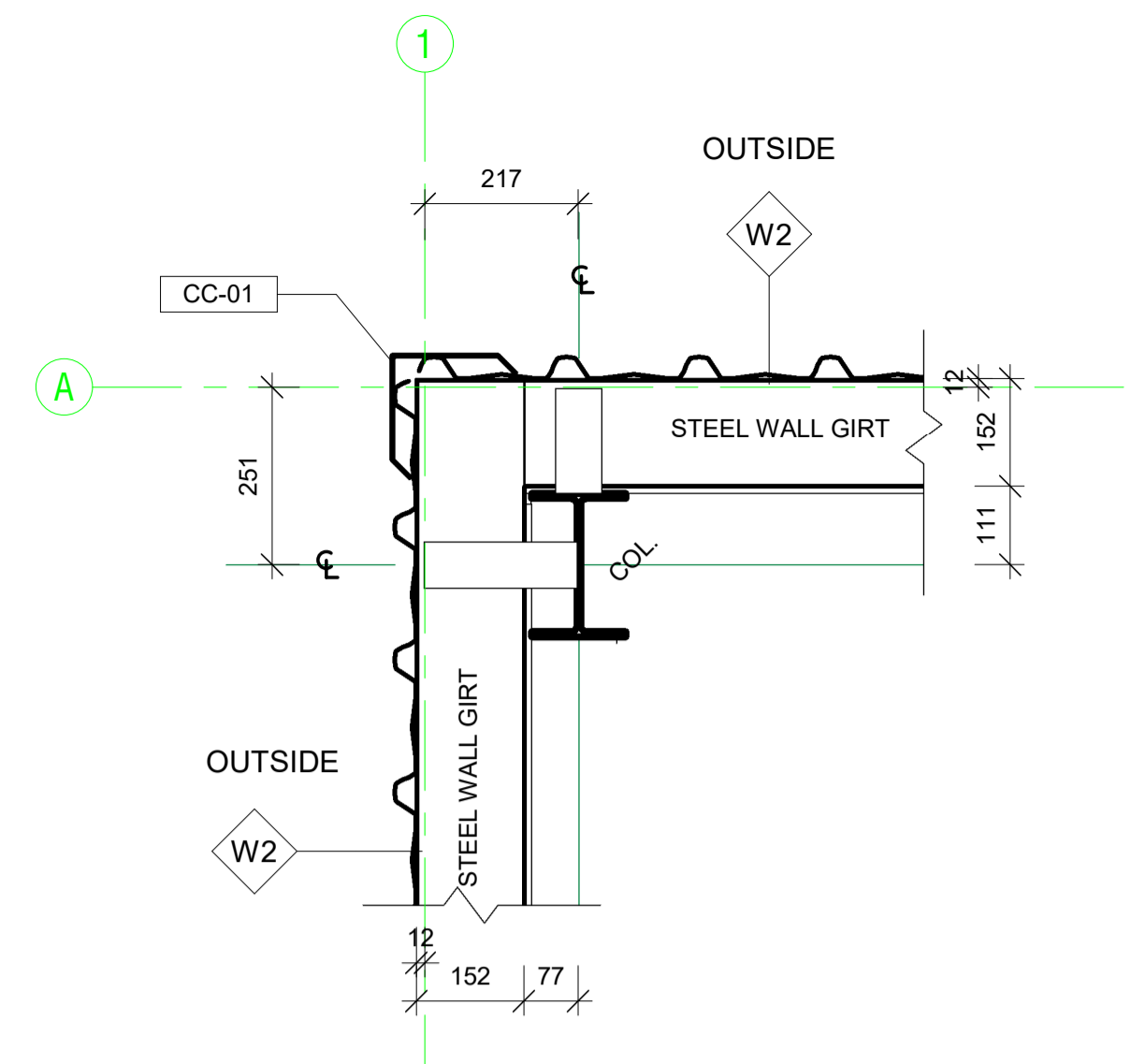

NOTE: TYPICAL DETAIL ABOVE 2400 AFFL
PD.02 Plan Detail PD.02
 1:10

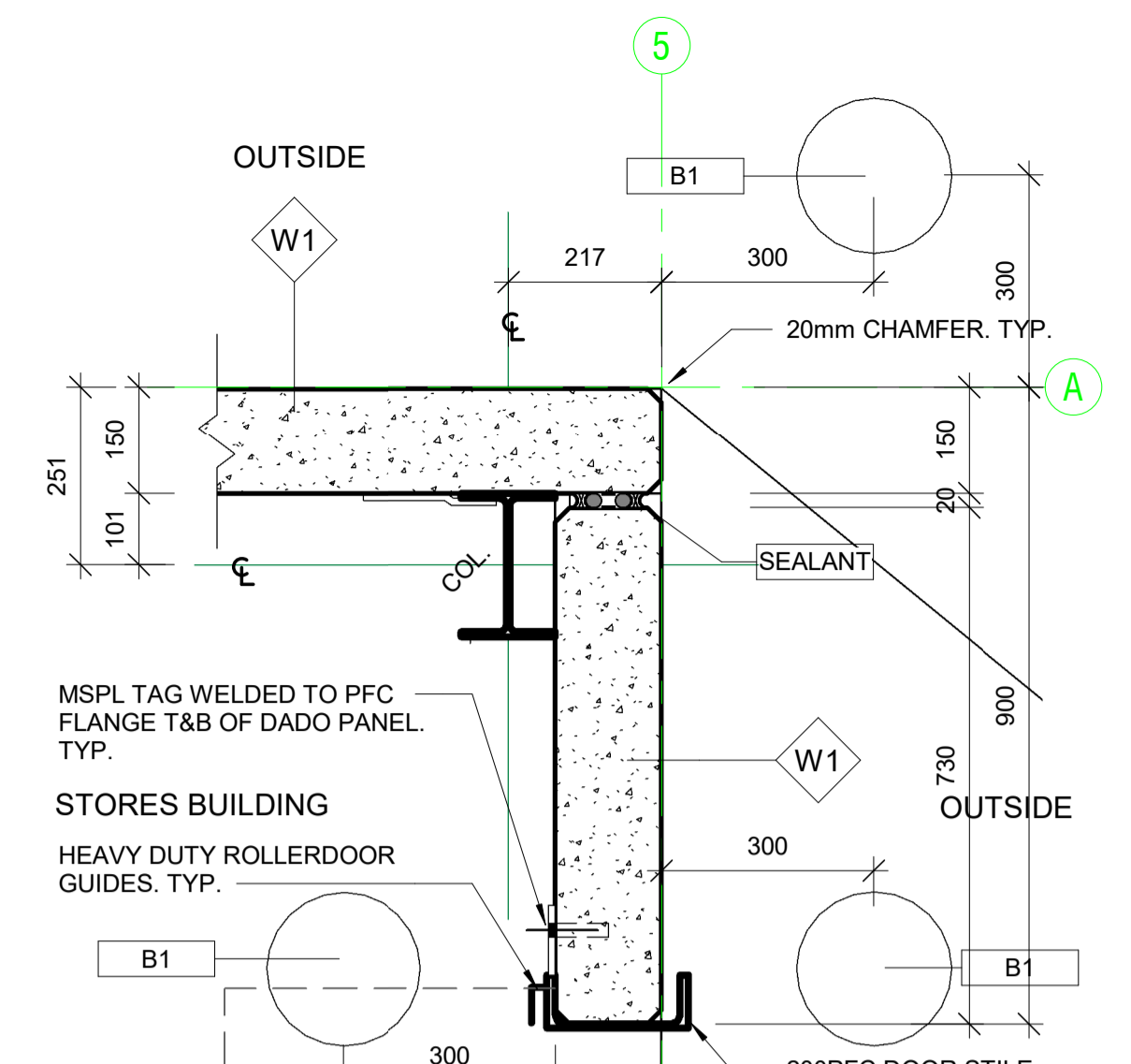

PD.03 Plan Detail PD.03
 1:10

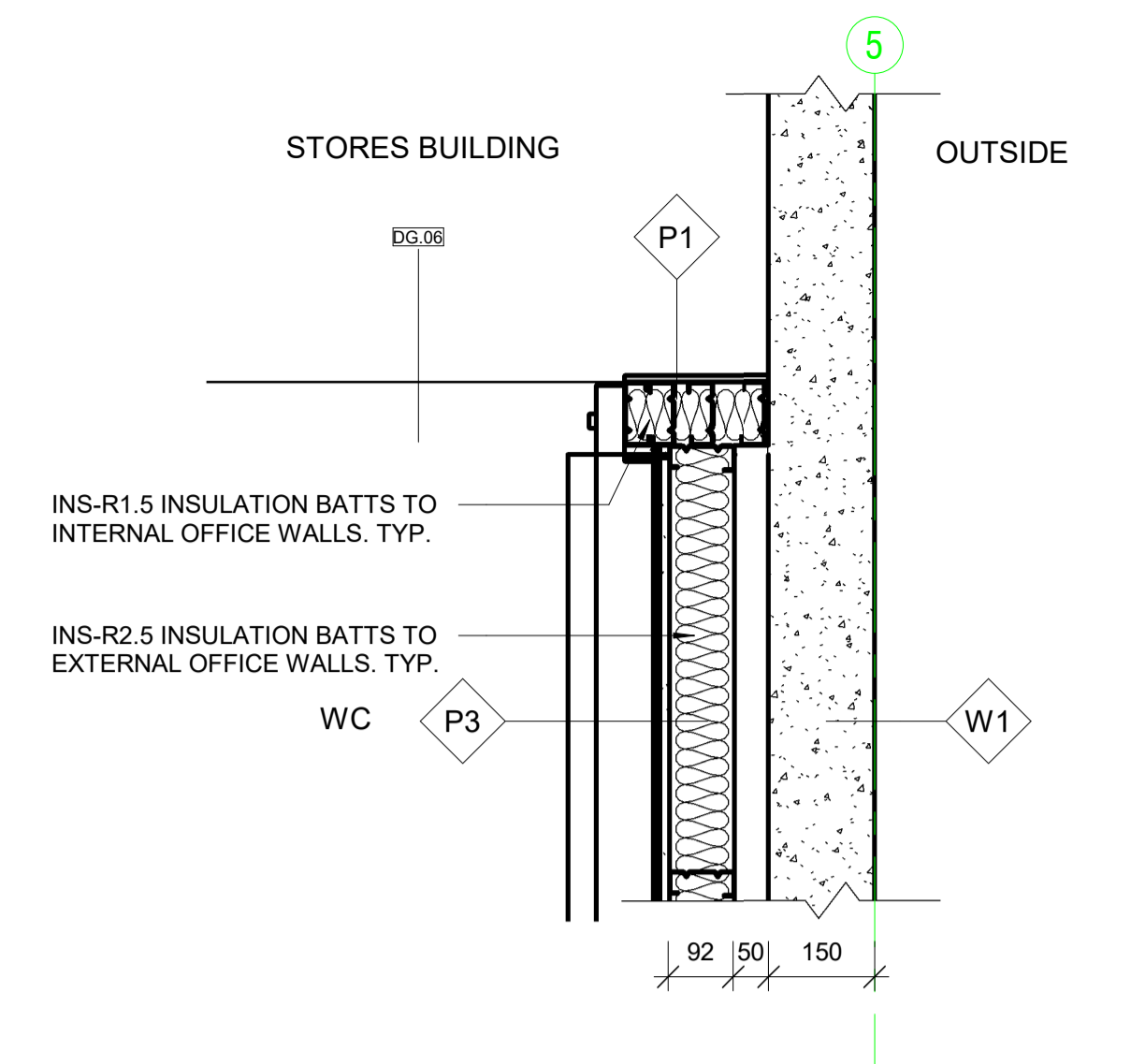

PD.05 Plan Detail PD.05
 1:10

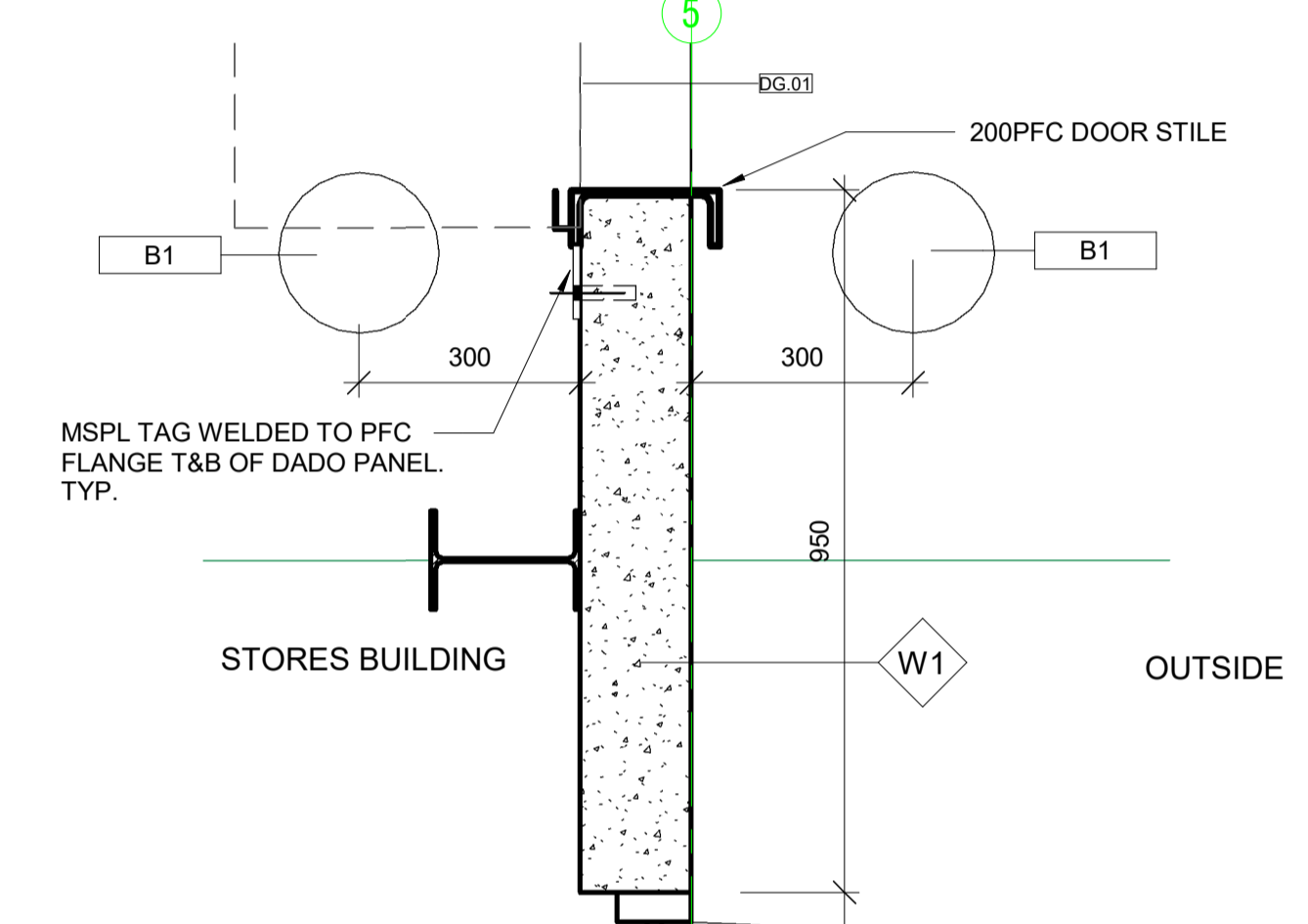

PD.04 Plan Detail PD.04
 1:10

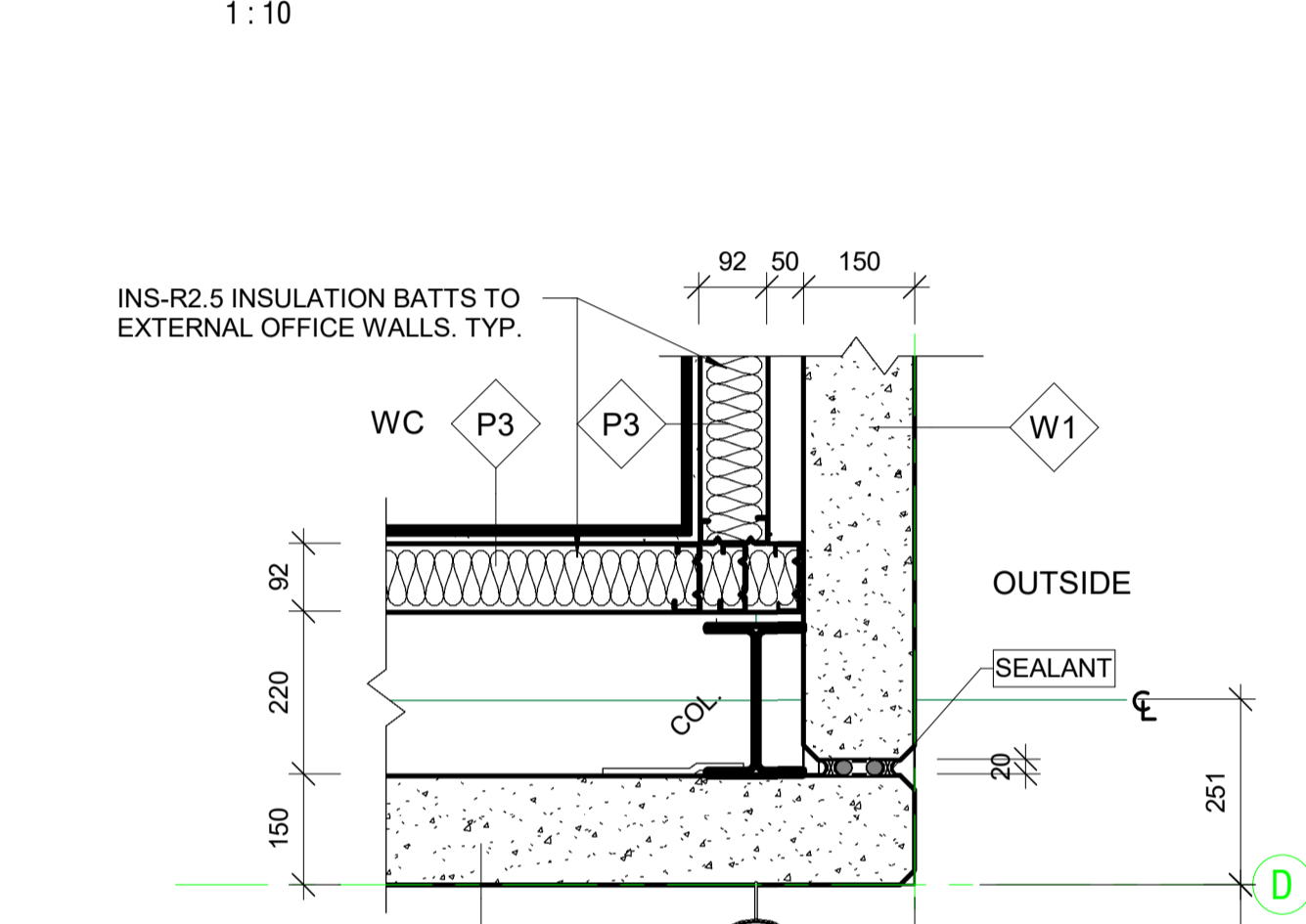

PD.06 Plan Detail PD.06
 1:10

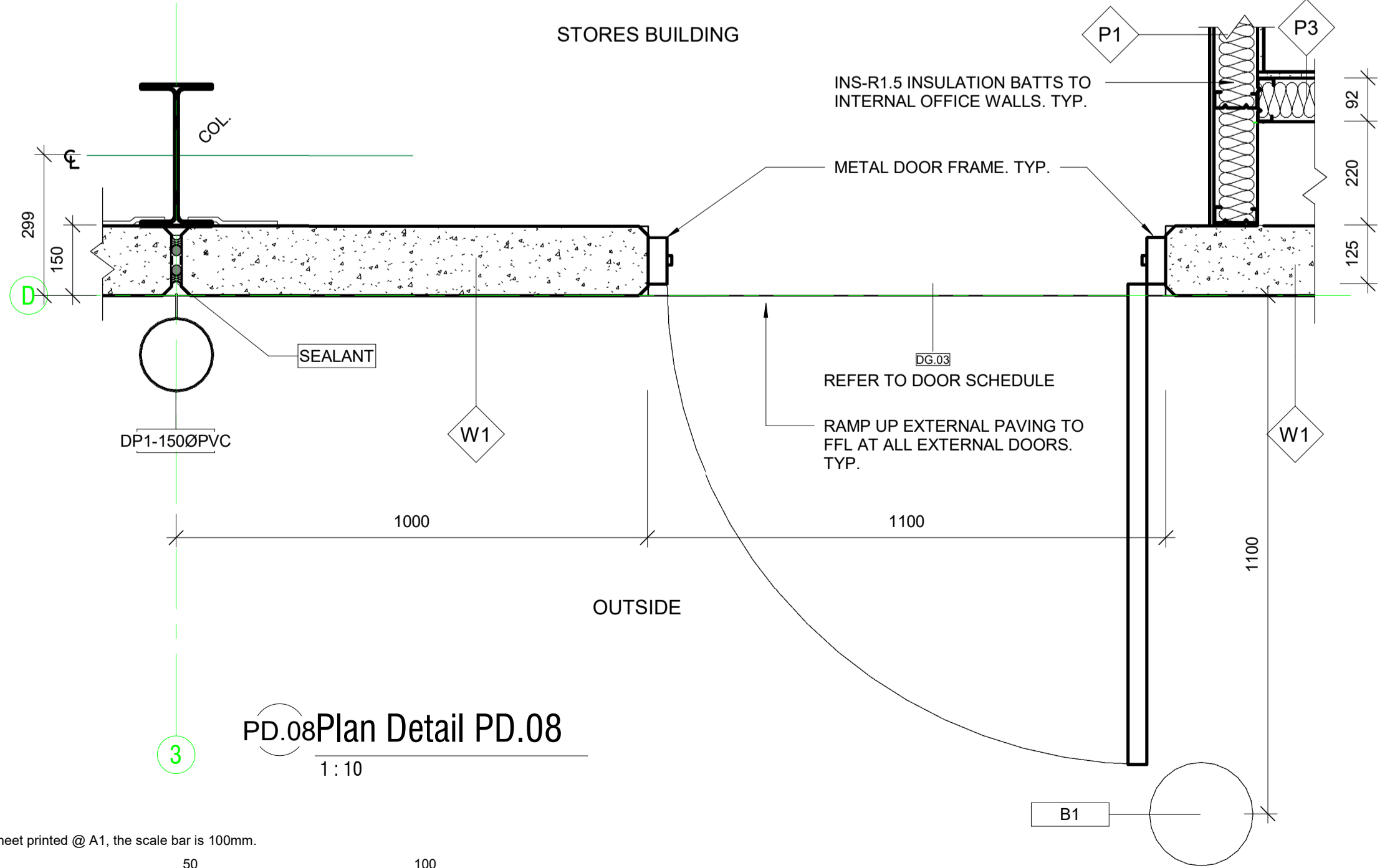

PD.08 Plan Detail PD.08
 1:10

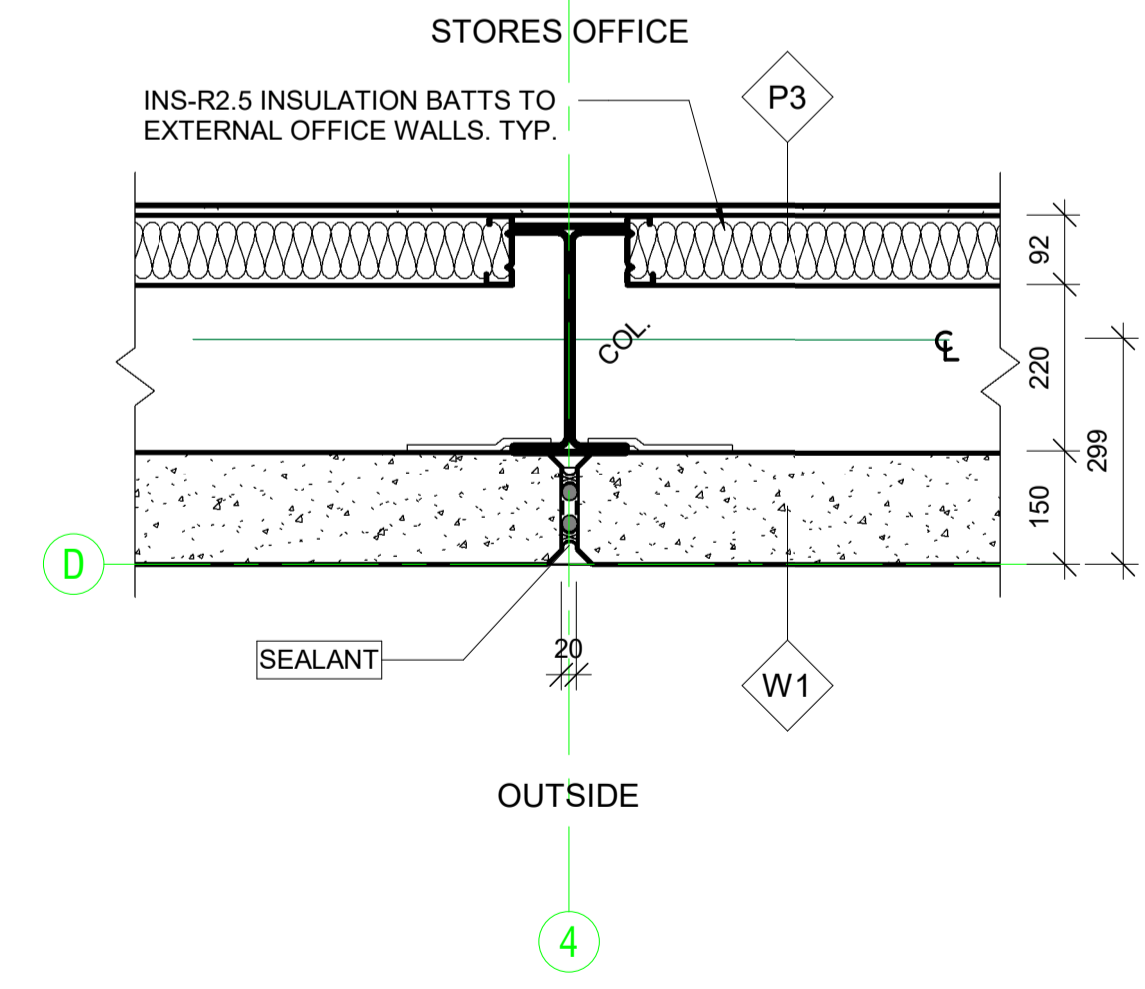

PD.07 Plan Detail PD.07
 1:10

Wall Schedule	
Type Mark	Description
P1	92mm stud @ 600cts max. Line externally to warehouse with: 1x9mm flush jointed Villaboard and internally to office with 1x13mm Plasterboard. Moisture resistant P/board to all wet areas with 92mm stud @ 450cts max.
P2	92mm stud @ 600cts max. Line both sides with 1x13mm flush jointed Plasterboard. Moisture resistant P/board to all wet areas with 92mm stud @ 450cts max.
P3	92mm stud @ 600cts max. Line one side only with 1x13mm flush jointed Plasterboard. Moisture resistant P/board to all wet areas with 92mm stud @ 450cts max.
W1	150mm thick Precast Concrete Panel dado wall with steel float finish. - Class 2 Finish. Painted.
W2	Z150 Structural steel wall girts, clad externally with 0.48 Colorbond Trimdek wall cladding.

Tag	Description
B1	219 CHS steel Bollard x 1500mm high. Concrete filled with Cap. Painted yellow. Refer to Civil Details.
CC-01	Corner capping - Colorbond.
DP1-1500PVC	150 Dia PVC Downpipe. Connect into in-ground stormwater system. Painted.
SEALANT	Continuous sealant

A ISSUED FOR CONSTRUCTION 26/11/21
 Issue Amendments Date
 Project Proposed Stores Building for SCT Logistics Lot 93 Pellew Road, Penfield. SA

Drawing **PLAN DETAIL SHEET**

TSDB
 16-22 Erudina Ave, Edwardstown S.A. 5039
 Ph (08) 8277 0111
 Industrial - Commercial - Educational

Date: 11/10/21
 Drawn: TB
 Scale: 1:10 (@ A1) or (@ A3)
 Project Number: 0555

© COPYRIGHT Drawing Number: **A07-1.A**
 Contractors must verify all dimensions at the job commencing work or making shop drawings.

Not for Construction until approved by Statutory Authorities before commencing work or making shop drawings.

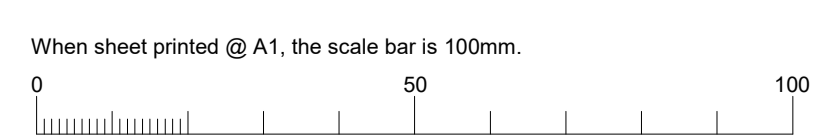

26/11/2021 11:02